

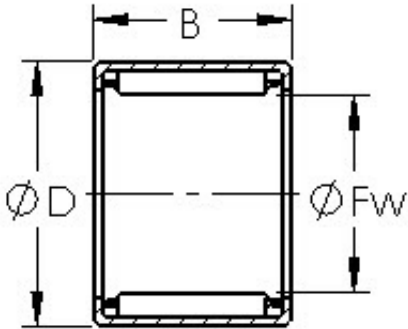

Shandong Chik Bearing Co., Ltd.



AST HK0808 needle roller bearings

Bearing No. HK0808

Size	8x12x8 mm
Bore Diameter	8 mm
Outer Diameter	12 mm
Width	8 mm
Bearing Type	Cage Retained Rollers
Outer Dia (D)	12.0000
Width (B)	8.0000
Dynamic Load Rating (Cr)	2,750
Static Load Rating (Cor)	2,600
Max Speed (Grease) (X1000 RPM)	28,000
Shaft (Fw)	8.000
Weight (g)	3.00
Material - Drawn cup: Hardened carbon steel alloy, Rollers	52100 Chrome steel or equivalent

HK0808 Bearing 2D drawings and 3D CAD models